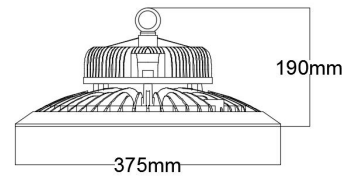
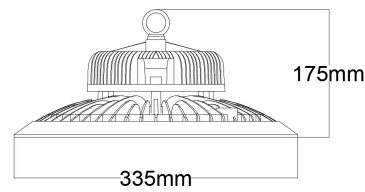
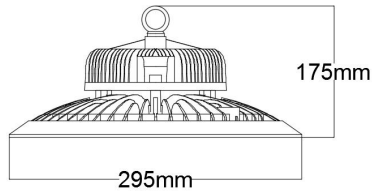
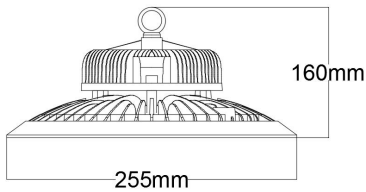

Mosun UFO Led High Bay Light A Specification

1、Picture and size

60w
100w
150w
200w

2、Features

- 1) Using 6063 4.0mm thick aluminum plate conduction heat, stereoscopic ventilation convection increase heat conduction.
- 2) Lamps adopting ventilation stamping, hydraulic, spinning process technology, flying saucer shape design, The overall appearance have full sense of technology and sense of product design, beauty.
- 3) Using waterproof apron sealing process, waterproof grade reach IP 65 and dust-proof.
- 4) Adopting respirator design, waterproof and dust-proof product protective film can balance pressure lamp shell inside and outside when temperature and pressure change, large breathable, fine porous structure, waterproof and dust-proof breathable plug prevent leakage by balancing the pressure inside the housing and the environment, so that reducing the pressure on the seal, prevent condensation, fog, improve product life.
- 5) The use of pure aluminum plate, under the cover buttoned structure, so that the lamp is more robust, durable.

Applications: Widely used in high shed plant, workshop, warehouse, logistics center, exhibition hall, gymnasium, shipyard, mine, highway toll stations, gas stations, supermarkets, farmers market and other places.

3、 Technical parameters

Model:	MS-YHB60W-A	MS-YHB100W-A	MS-YHB150W-A	MS-YHB200W-A
Power:	60W	100W	150W	200W
Led Source:	Philips-3030LED	Philips-3030LED	Philips-3030LED	Philips-3030LED
Driver:	Meanwell	Meanwell	Meanwell	Meanwell
Led Qty:	60pcs	110pcs	160pcs	210pcs
Working voltage:	AC85-265V	AC85-265V	AC85-265V	AC85-265V
Beam angle:	120°	120°	120°	120°
Lumen:	8400lm	14000lm	21000lm	28000lm
Power Factor:	>0.95	>0.95	>0.95	>0.95
Correlated Color Temperature:	2700-6500K	2700-6500K	2700-6500K	2700-6500K
Color rendering index:	>80	>80	>80	>80
IP Rating:	IP65	IP65	IP65	IP65
Material	Aluminum Alloy	Aluminum Alloy	Aluminum Alloy	Aluminum Alloy
Weight:	3.05kg	4.1kg	5.3kg	7kg
Dimensions:	255×255×160mm	295×295×175mm	335×335×175mm	375×375×190mm

4、 Testing Data

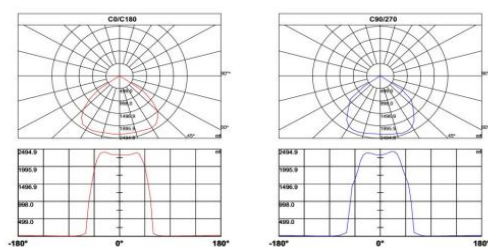
A 60w Led High Bay Light

Lux-Distance Curve

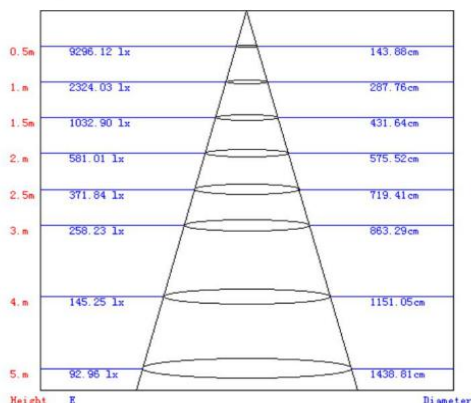
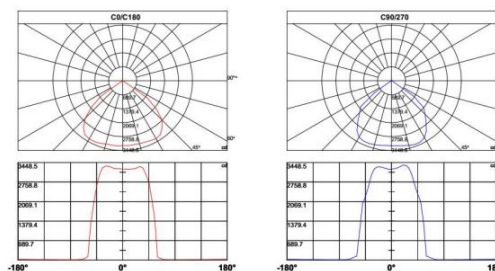

B 100w Led High Bay Light

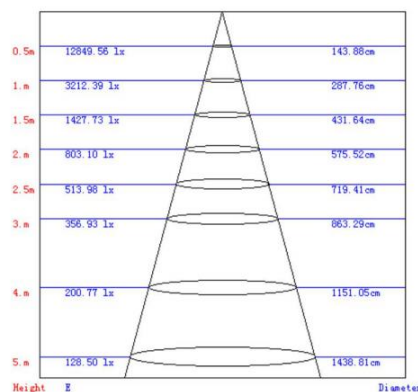
Lux-Distance Curve

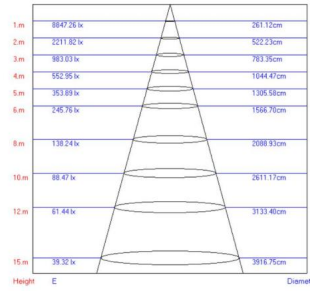
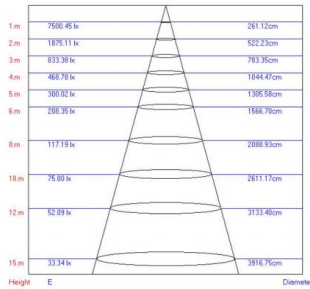
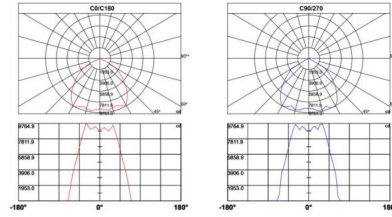
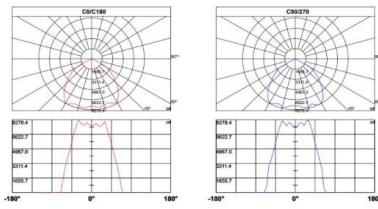

C 150W Led High Bay Light

D 200W Led High Bay Light



5、 Package

Item	MS-YHB60W-A	MS-YHB100W-A	MS-YHB150W-A	MS-YHB200W-A
Package Qty	1pcs	1pcs	1pcs	1pcs
GW	3.05kg	4.1kg	5.3kg	7kg
Inner Box Size	305*305*200mm	345*345*215mm	385*385*215mm	425*425*230mm

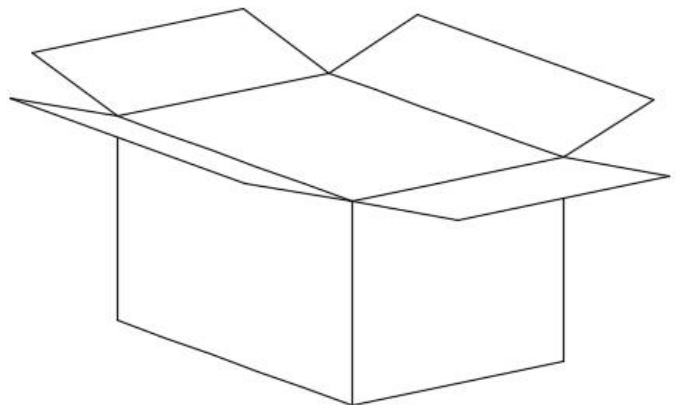
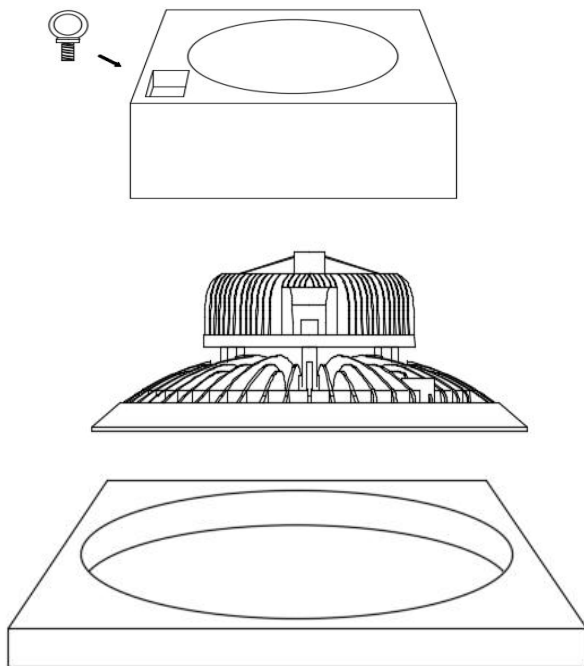

6、 Installation Instructions

Attention:

- 1) Be sure disconnect power before installing, don't construction with electricity.
- 2) Product working voltage is AC85~265V,50/60Hz, Please do not exceed the working voltage range.
- 3) Input product line, brown is **L**, blue is **N**, yellow-green is **GND**.
- 4) Be sure wiring is closed and prevent leakage, when installing.
- 5) The lamp can not be used in violation of any fire regulations.

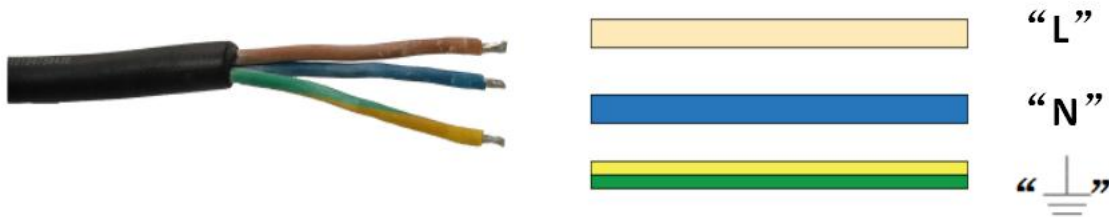

Installation and schematic:

